

Pushbuttons, Indicating Light, and Rotary Switch Stations

Series 4975

Series 4975 Pushbutton Stations are designed for shipboard control applications requiring heavy duty watertight master switches. Stations are available with one, two or three elements equipped with maintained or momentary contacts and with indicating lights. For panel or switchboard mounting individual N.O., N.C. or D.T. elements can be supplied.

Specification	MIL-C-2122
Operation	Manual
Enclosure	Watertight (without space heater*)
Duty	Continuous
Ambient	50° C
Insulation	Class B
Ratings	1 Amp., 250 volts D.C. 5 amps., 500 volts A.C.

*Space heater can be furnished.



Pushbutton element for panel or switchboard mounting

Ordering Information

1. Specify Type Number, i.e. NS101-1
2. For special assemblies specify-
 - A- Number of elements and location
 - B- Type of elements and legend plate marking
 - C- Indicator lens color, if required and circuit voltage

Indicating Lights

Indicating lights for 115 or 440 volt A.C. or 115 or 230 volt D.C. service can be included in one, two, or three button stations. Lights for 440 volt A.C. service are of the transformer type. Clear, red, blue, amber or green lenses are available.

Pushbuttons Stations

Series 4975

Control Station (Two Elements)					Control Station (One Element)		
Type of Element		Legend Plate Marking***		Type Nos.	Type of Element	Legend Plate Marking***	Type Nos.
Top	Bottom	Top	Bottom				
N.O.	N.O.	Open	Close	NS201-1	N.O.	Start	NS101-1
D.T.	D.T.	Positive	Negative	NS203-1	N.O.	Reset	NS101-2
D.T.	D.T.	Start	Open	NS203-2	N.O.	Start Emergency	NS101-3
					N.O.	Emergency Run	NS101-4
D.T.	D.T.	Open	Close	NS203-3	N.C.	Stop	NS102-1
Blue Lens**	Amber Lens**	(specify)	(specify)	NS204T3	N.C.	Test	NS102-2
Red Lens**	White Lens**	(specify)	(specify)	NS204T4	N.C.	Emergency Stop	NS102-3
D.T.	D.T.	Man.-Auto.	Slow-Fast	NS205-1	D.T.	Emergency Stop	NS103-1
N.O.	N.C.	Start	Stop	NS207-1	Red Lens*	(specify)	NS104-1
N.O.	N.C.	Start Emer.	Stop	NS207-2	Green Lens*	(specify)	NS104-2
N.O.	N.O.	Emer. Run	Stop-Start	NS213-1	Red Lens*	(specify)	NS104-T3
Red Lens*	N.O.	(specify)	Stop-Start	NS216-1	Green lens*	(specify)	NS104-T4
D.T.	N.O.	Man.-Auto.	Stop-Start	NS221-1	N.O.	Off - On	NS105-1
					N.O.	Stop - Start	NS105-2
D.T.	N.O.	Slow-Fast	Stop-Start	NS221-2	N.O.	Stop - Run	NS105-3
N.O.	N.C.	Start	Stop	NS230-1	D.T.	Man. - Auto	NS106-1
					D.T.	Slow - Fast	NS106-2

Control Station (Three Elements)						
Type of Element			Legend Plate Marking***			Type Nos.
Top	Center	Bottom	Top	Center	Bottom	
D.T.	D.T.	N.C.	Fast	Slow	Stop	NS309-1
D.T.	D.T.	N.C.	Fast Emer.	Slow Emer.	Stop	NS309-2
D.T.	D.T.	N.C.	Forward	Reverse	Stop	NS309-3
Green Lens*	D.T.	D.T.	Motor Running	Off-On	Run-Auto	NS320-1
D.T.	D.T.	N.O.	Man.-Auto	Slow-Fast	Stop-Start	NS321-1
N.O.	N.O.	N.C.	Emer. Run	Start	Stop	NS322-1
Red Lens*	N.O.	N.C.	(specify)	Start	Stop	NS338-1
Red Lens*	N.O.	N.C.	Motor Running	Start	Stop	NS338-2
Green Lens**	N.O.	N.C.	Power On	Start	Stop	NS338T4
Red Lens**	N.O.	N.C.	Motor Running	Start	Stop	NS338T5
D.T.	N.O.	N.C.	Slow-Fast	Start	Stop	NS340-1
D.T.	N.O.	N.C.	Man-Auto	Start	Stop	NS340-2
D.T.	N.O.	N.C.	Slow-Fast	Start Emer.	Stop	NS340-3
Red Lens*	N.O.	N.O.	Power On	Start	Off-On	NS347-1
Red Lens**	N.O.	N.O.	Power On	Start	Off-On	NS347T2
Red Lens*	N.O.	D.T.	(specify)	Emer. Run	Man-Auto	NS360-1









* For 115 volt circuits

** For 440 volt circuits

*** Legend plate markings other than the markings listed available. The maximum number of characters per legend plate is 14.

Pushbuttons Stations































Series 4975

 Momentary Contact Open	 Momentary Contact Closed	 Ind. Lamp
 Maintained Contact Double Throw	 Maintained Contact Single Throw	 Ind. Lamp with Transformer
 Momentary Contact Normally Open and Closed	 Momentary Contact Normally Open	

Key to Symbols

Special Assemblies

Type	Marking	Description
2-Button	(specify)	(2) Indicator Lights - 115 V
2-Button	(specify)	(2) Indicator Lights - 440/6 V
3-Button	(specify)	(3) Indicator Lights - 115 V
3-Button	(specify)	(3) Indicator Lights - 440/6 V

One Element Station													
Two Element Station													
Three Element Station													

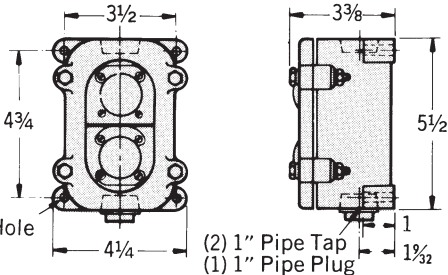

One and Two Button Stations.

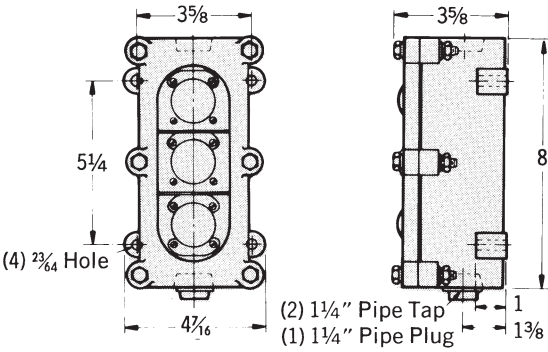

Three Button Station.

Diagram Symbols

Switchboard Mounted Units (Dropproof or Watertight)

Standard Contact Arrangement

- N.O., N.C., or D.T. Pushbutton – momentary
- D.T., 2-position Rotary Switch – maintained
- 3-point N.O. Pushbutton – momentary

Pushbutton, Indicating Light, and Rotary Switch Stations

Type IC5844

Specification	MIL-C-2212
Application	Control of magnetic starters from remote locations. Surface mounted.
Enclosure	Watertight. Conduit entrance, top or bottom.
Pushbuttons	Momentary contact type.
Selector Switches	Both spring return and maintaining contacts available.
Indicating Lights	Dual-lamp type. Uses T-1 ³ / ₄ midget screw lamps.
Duty.	Continuous
Ambient	50° C

Ordering Information

- Order by complete catalog number. The most frequently ordered standard stations are listed on page 48. Order these stations by the complete catalog number listed whenever possible.
- Order by complete description, including
 IC number
 Quantity and type of each element desired
 Nameplate marking (lens cap marking if indicating element)

Example: IC5844L containing one indicating light element
 1G marked "motor running" and one rotary switch element 3 marked "stop" (pos c) and "run" (pos D)

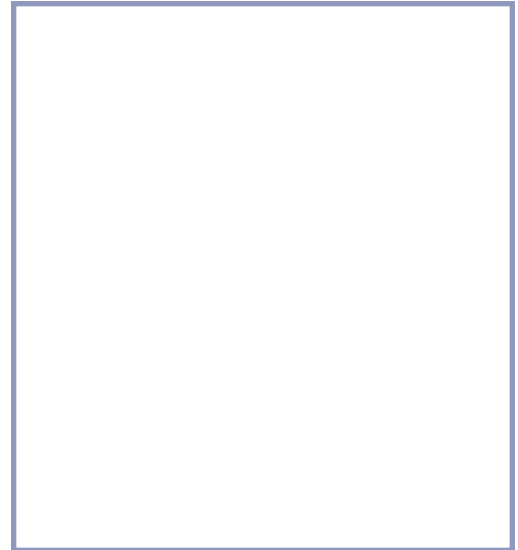

Basic Station	Maximum Number of Elements
IC5844K	2
IC5844L	3
IC5844M	5

Electrical Ratings

Rating	Amperes (Inductive circuit)				
	A.C., 60 Hz			D.C.	
	115 V	230 V	440 V	115 V	230 V
Push Button					
Make	60	60	60	60	60
Break	6	3	1.5	2.2	1.1
Carry	10	10	10	10	10
Selector Switch					
Make	10	8	5	8	5
Break	10	5	3	5	2
Carry	10	10	10	10	10

Pushbuttons, Indicating Light, and Rotary Switch Stations

Type IC5844

Electrical Arrangements

Element Arrangement		Order Station Type
One pushbutton		IC5844K
Two pushbuttons		IC5844K
Three pushbuttons		IC5844L
Four pushbuttons		IC5844M
Five pushbuttons		IC5844M
One indicating light		IC5844K
Two indicating lights		IC5844K
Three indicating lights		IC5844L
Four indicating lights		IC5844M
Five indicating lights		IC5844M
One rotary switch		IC5844K
Two rotary switches		IC5844L
Three rotary switches		IC5844M
One P.B. with	One indicating light	IC5844K
	Two indicating lights	IC5844L
	One rotary switch	IC5844L
	One ind. light and one rotary sw.	IC5844L
Two P.B. with	One indicating light	IC5844L
	Two indicating lights	IC5844M
	Three indicating lights	IC5844M
	One rotary switch	IC5844L
	Two rotary switches	IC5844M
Three P.B. with	One indicating light	IC5844M
	Two indicating lights	IC5844M
	One rotary switch	IC5844M
	Two rotary switches	IC5844M
One I.L. with	One rotary switch	IC5844L
Two I.L. with	One rotary switch	IC5844L
Refer to Company for arrangements not listed.		



Pushbuttons, Indicating Light, and Rotary Switch Stations

Type IC5844

PUSHBUTTON ELEMENTS				
<p>ELEMENT 1P</p> <p>1 NO MOMENTARY CONTACT</p>	<p>ELEMENT 2P</p> <p>1 NC MOMENTARY CONTACT</p>	<p>ELEMENT 3P</p> <p>1 NO AND 1 NC MOMENTARY CONTACT</p>	<p>ELEMENT 4P</p> <p>2 NO MOMENTARY CONTACTS</p>	<p>ELEMENT 5P</p> <p>2 NC MOMENTARY CONTACTS</p>

INDICATING LIGHT ELEMENTS (SEE NOTE 1)									
ELEMENT	LENS COLOR	ELEMENT	LENS COLOR	ELEMENT	LENS COLOR	ELEMENT	LENS COLOR	ELEMENT	LENS COLOR
1A	AMBER	2A	AMBER	3A	AMBER	4A	AMBER	5A	AMBER
1B	BLUE	2B	BLUE	3B	BLUE	4B	BLUE	5B	BLUE
1C	CLEAR	2C	CLEAR	3C	CLEAR	4C	CLEAR	5C	CLEAR
1G	GREEN	2G	GREEN	3G	GREEN	4G	GREEN	5G	GREEN
1R	RED	2R	RED	3R	RED	4R	RED	5R	RED
1W	WHITE	2W	WHITE	3W	WHITE	4W	WHITE	5W	WHITE
440 VAC 60 Hz		115 VAC 60 Hz		230 VDC 230 VDC		115 VDC 115 VDC		28 VAC/ VDC	28 VAC/ VDC
TYPE TS-159 LAMPS		TYPE TS-159 LAMPS		SEE NOTE 1 TYPE TS-175 LAMPS		SEE NOTE 1 TYPE TS-175 LAMPS		TYPE TS-158 LAMPS	

Note 1: Series resistors R1 and R2 must be remote mounted and are not included.

Resistor	Ohms	Amps	Actual Watts
R1	2950	0.04	4.7
R2	1380	.04	2.2

ROTARY SWITCH ELEMENTS (SEE NOTES 2 AND 3)					
<p>ELEMENT 1S F C D</p> <p>MAINTAIN CONTACT x = CLOSED</p>	<p>ELEMENT 2S F C D</p> <p>MAINTAIN CONTACT x = CLOSED</p>	<p>ELEMENT 3S C D</p> <p>MAINTAIN CONTACT x = CLOSED</p>	<p>ELEMENT 4S C D</p> <p>MAINTAIN CONTACT x = CLOSED</p>	<p>ELEMENT 5S C D E</p> <p>← SPRING RETURN x = CLOSED MAKE BEFORE BREAK</p>	<p>Note 2: Location of rotary switch positions.</p> <p>FRONT VIEW</p>
<p>ELEMENT 6S F C D</p> <p>MAINTAIN CONTACT x = CLOSED</p>	<p>ELEMENT 7S F C D</p> <p>MAINTAIN CONTACT x = CLOSED</p>	<p>ELEMENT 8S F C D</p> <p>← SPRING RETURN x = CLOSED</p>	<p>ELEMENT 9S C D E</p> <p>MAINTAIN CONTACT x = CLOSED</p>	<p>ELEMENT 1T F C D</p> <p>SPRING RETURN → x = CLOSED</p>	
<p>ELEMENT 2T F C D</p> <p>SPRING RETURN → ← SPRING RETURN x = CLOSED</p>	<p>ELEMENT 3T C D</p> <p>MAINTAIN CONTACT x = CLOSED</p>	<p>ELEMENT 4T C D</p> <p>MAINTAIN CONTACT x = CLOSED</p>	<p>ELEMENT 5T F C D</p> <p>SPRING RETURN → ← SPRING RETURN x = CLOSED</p>	<p>ELEMENT 6T F C D</p> <p>SPRING RETURN → x = CLOSED</p>	<p>ELEMENT 7T C D</p> <p>← SPRING RETURN x = CLOSED</p>

Note 3: Contacts break before make, unless otherwise specified.

Pushbuttons, Indicating Light, and Rotary Switch Stations

Type IC5844

Standard Pushbutton Stations

Element(s) and Namplate Markings			
Position 1	Position 2	Position 3	Complete Catalog Number
1P Start	–	–	IC5844K1PXXXX04AA
2P Stop (red)	–	–	IC5844K2PXXXX04AE
1P Emer. Run	–	–	IC5844K1PXXXX04AB
2P Emer Stop (red)	–	–	IC5844K2PXXXX04AC
1P Reset	–	–	IC5844K1PXXXX04AD
1P Test	–	–	IC5844K1PXXXX04AG
1P Bypass	–	–	IC5844K1PXXXX04AH
1P Start	2P Stop (red)	–	IC5844K1P2PXX01AA
1P On	2P Off	–	IC5844K1P2PXX01AF
3P Hoist	3P Lower	–	IC5844K3P3PXX01AB
3P Forward	3P Reverse	–	IC5844K3P3PXX01AE
3P High Speed	3P Low Speed	–	IC5844K3P3PXX01AN
3P Fast	3P Slow	2P Stop (red)	IC5844L3P3P2P07AA
3P Forward	3P Reverse	2P Stop (red)	IC5844L3P3P2P07AJ
3P Hoist	3P Lower	2P Stop (red)	IC5844L3P3P2P07AH
1P Start	2P Stop (red)	1P Emer. Run	IC5844L1P2P1P07AD
3P High Speed	3P Low Speed	2P Stop (red)	IC5844L3P3P2P07AG

Standard Rotary Switch Stations

Element(s) and Namplate Markings (All Stations Are Single Element)		Complete Catalog Number
3S Stop (red) – Start		IC5844K3SXXXX03AA
3S Off – On		IC5844K3SXXXX03AB
4S Local – Remote		IC5844K4SXXXX03AC
4S Manual – Auto		IC5844K4SXXXX03AP
1S Manual – Off – Auto		IC5844K1SXXXX03MA
1S Slow – Stop (red) – Fast		IC5844K1SXXXX03MN
1S Raise – Stop (red) – Lower		IC5844K1SXXXX03MH

Standard Combination Stations

Element(s) and Namplate Markings			
Position 1	Position 2	Position 3	Complete Catalog Number
1G Motor Running	1P Start	2P Stop (red)	IC5844L1G1P2P10AA

Standard Indicating Light Stations

Element(s) and Namplate Markings		
Position 1	Position 2	Complete Catalog Number
1G Motor Running	–	IC5844K1GXXXX06AA
1W Power Available	–	IC5844K1WXXXX06AB
1G Fast	1G Slow	IC5844K1G1GXX02AA
1G High Speed	1G Low Speed	IC5844K1G1GXX02AB
1G Up	1G Down	IC5844K1G1GXX02AC

Pushbuttons, Indicating Light, and Rotary Switch Stations

Type IC5844

Outline and Mounting Dimensions (In Inches)

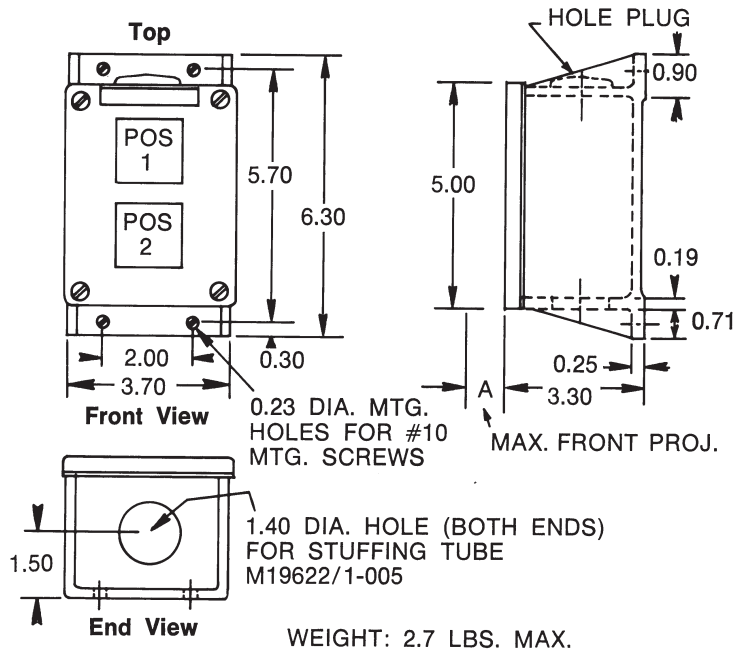

Type IC5844K

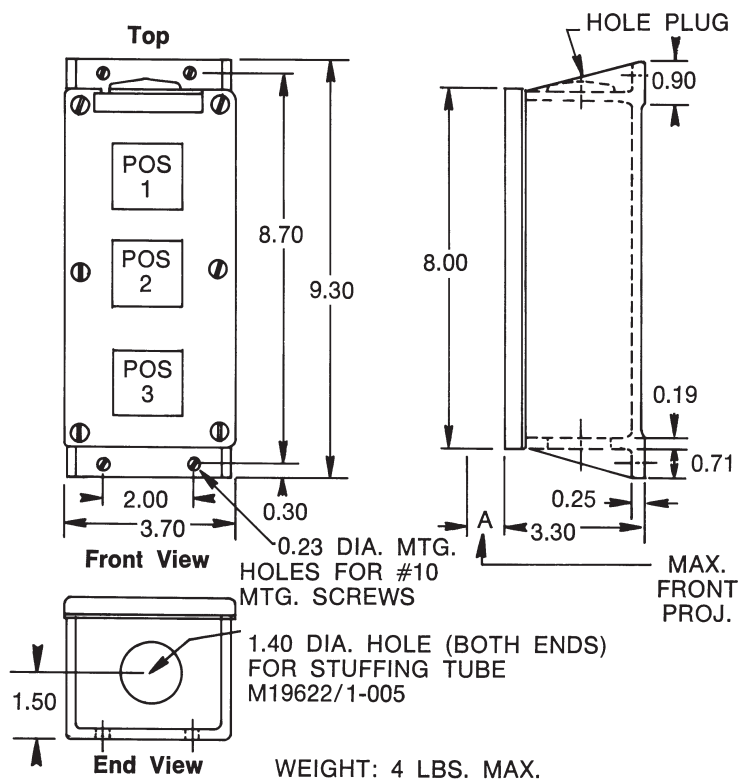

Type IC5844L

Pushbuttons, Indicating Light, and Rotary Switch Stations

Type IC5844

Outline and Mounting Dimensions (In Inches)

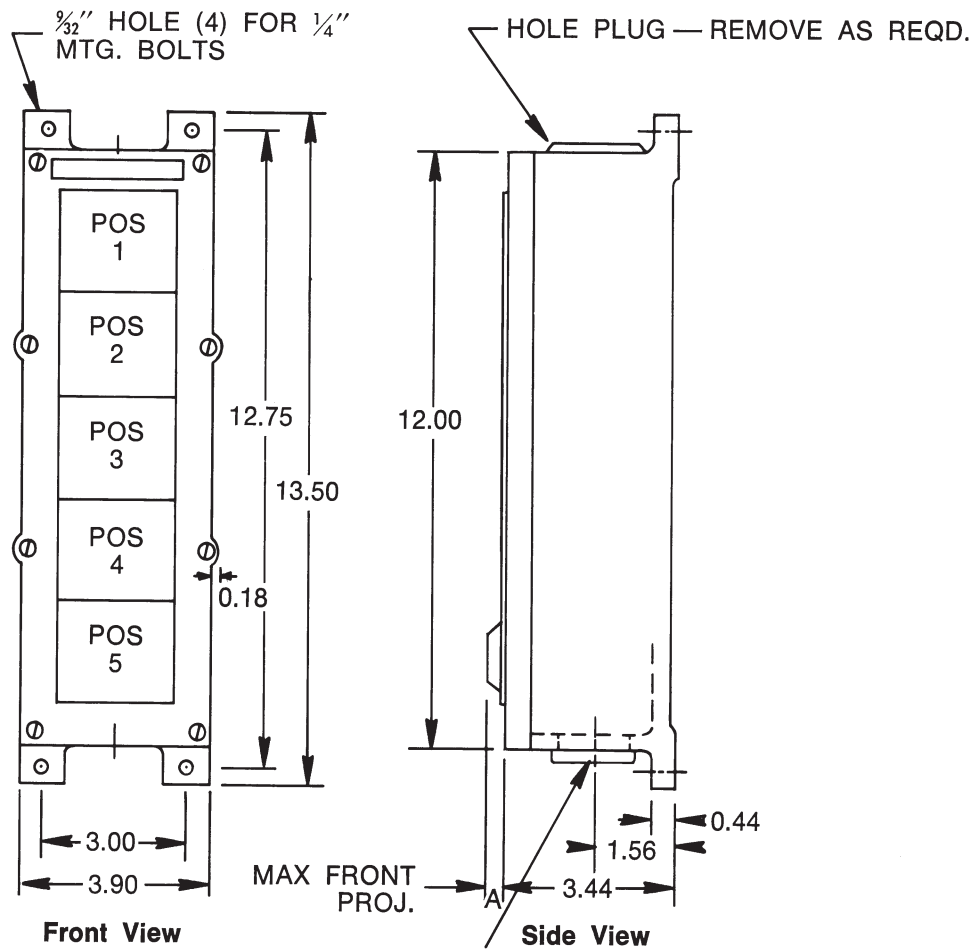

2.01 DIA. HOLE (ONE END)
 FOR SIZE 5 STUFFING TUBE
 M19622/1-006, 1.40 DIA. HOLE
 IN OTHER END FOR SIZE 4T
 STUFFING TUBE M19622/1-005

ELEMENT	A DIM.
PB	0.30
IL	0.30
ROT. SW	1.15

WEIGHT: 8 LBS. MAX.